

COOLING SYSTEM PARTS

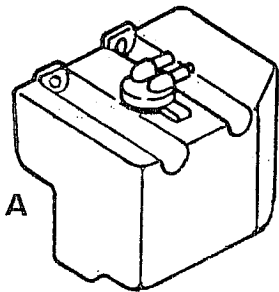

A

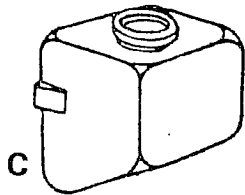

C

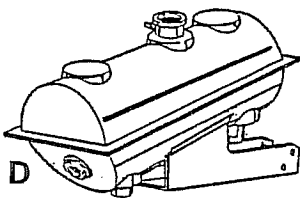

D

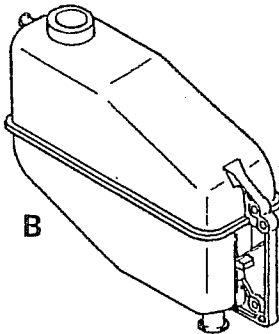

B

COOLANT TANKS

- LK0347 Blue Bird
- LK0349 Ford
- LK0434 Freightliner
- LK0359 GM
- LK0353 IH
- LK0547 Thomas

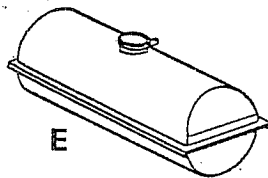

E

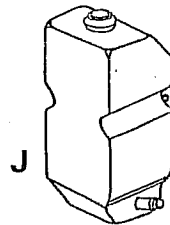

J

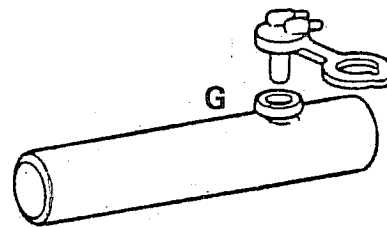

Caps
LK0940

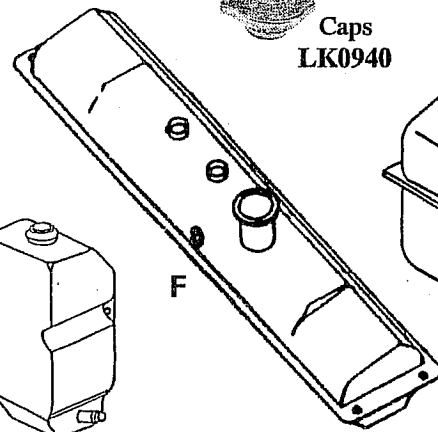

F

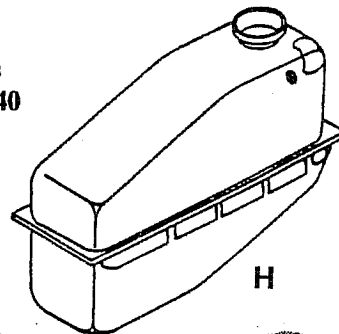

H



Sight Glass
LK1106

BELT TENSIONERS - IDLER PULLEYS

- LK0368 Blue Bird
- LK0370 Ford
- LK0432 Freightliner
- LK0365 GM
- LK0367 IH
- LK0135 Thomas

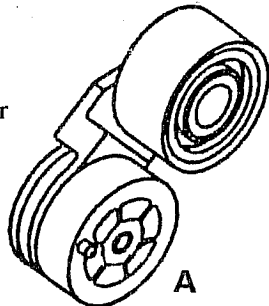

A

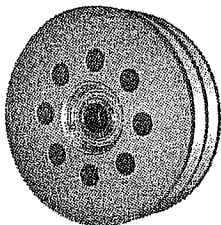

B

RADIATOR FANS

- LK0437 Blue Bird
- LK0431 Ford
- LK0441 Freightliner
- LK0433 GM
- LK0436 IH

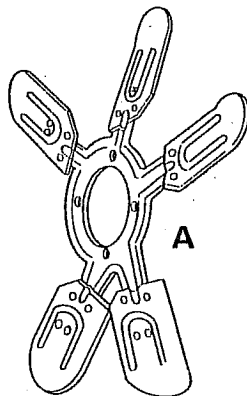

A

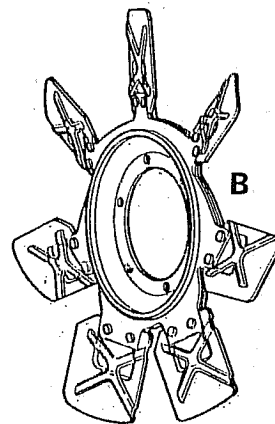

B

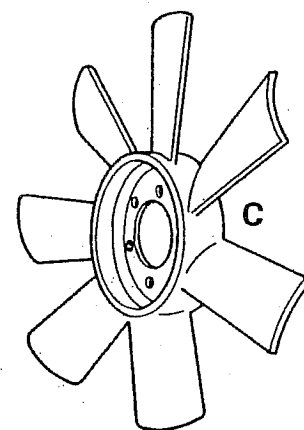

C

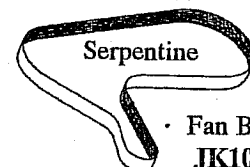

Serpentine

Fan Belts
JK1067

FAN CLUTCHES

- LK0369 Blue Bird
- LK0360 Ford
- LK0438 Freightliner
- LK0364 GM
- LK0366 IH

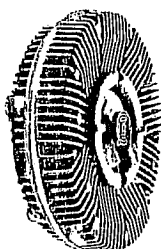
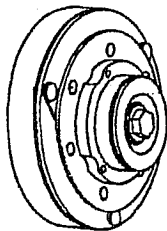
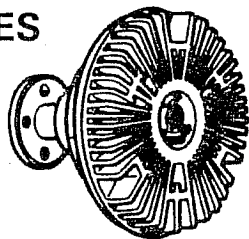

THERMAL SWITCHES

- LK0442 Blue Bird
- LK0450 Ford
- LK0461 Freightliner
- LK0449 GM
- LK0444 IH

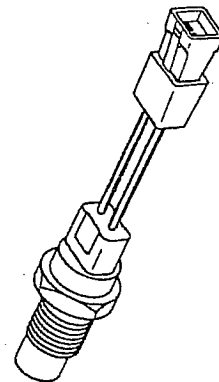
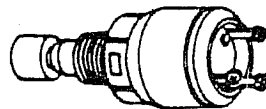
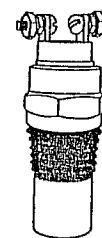

These Switches are for control of Fan Clutches and Radiator Shutters.

RADIATOR HOSES

- LK0462 Blue Bird
- LK0467 Ford
- LK0472 Freightliner
- LK0475 GM
- LK0481 IH

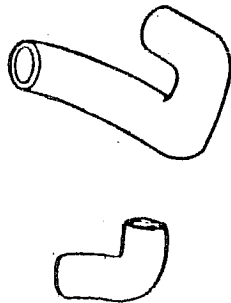
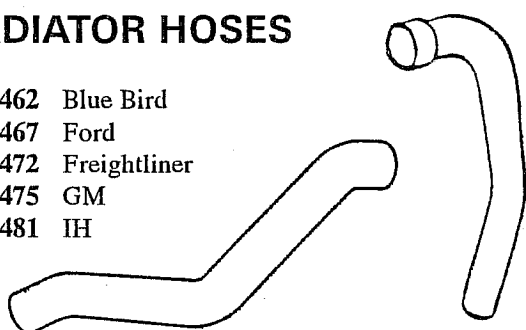

LOW-COOLANT SENSORS

- JK0311 Blue Bird
- JK0312 Ford
- JK0313 Freightliner
- JK0314 GM
- JK0315 IH

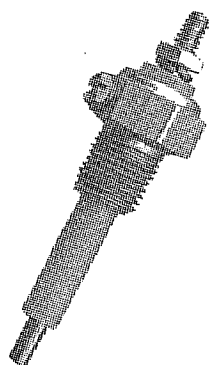

Sensor shown is used on Blue Bird & IH

.....Prevent Wet-Sleeve Corrosion.....



Save Your Engine....Test Your Coolant!

COOLANT TEST KITS For Wet-Sleeve Engines

- LK5896 Test Kit - 4-Strips
- LK5881 Test Kit - 50-Strips
- LK5889 Coolant Additive - 1 Pint
- LK5944 Coolant Additive - 1 Quart
- LK2959 Technical Bulletin.... "Diesel Coolant System Care & Maintenance"