

LH or RH Threads?

If you're ordering just (1) tie rod end, check carefully so that you'll know whether you need RH or LH threads. Sometimes, the whole tie rod assembly is reversed and is installed backwards.

# TIE ROD ENDS

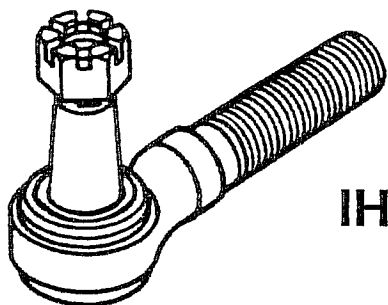
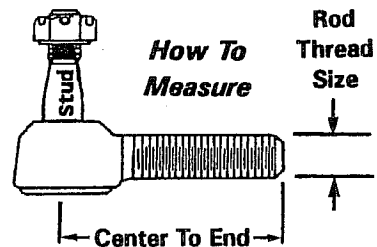

**IHC**

LH Threads Part No.	RH Threads Part No.	Length Center To End	Axle Size	Usage	Rod Thread Size	Stud Thread Size
LK4741-L	LK4742-R	3.88"	5-7500	1965-79	1" - 16	5/8" - 18
LK4733-L	LK4734-R	4.43"	5-8000	1965-89	1" - 16	3/4" - 16
LK4906-L	LK4907-R	11.89"	6-8000	1990 & Nwr	1-3/8" - 12	7/8" - 14
LK4749-L	LK4750-R	5.00"	9000	1965 & Nwr	1-1/8" - 12	7/8" - 14
LK4753-L	LK4754-R	9.19"	9-10800	1975 & Nwr	1-1/8" - 12	7/8" - 14
LK5813-L	LK5809-R	5.44"	10-12000	1979 & Nwr	1-1/2" - 12	7/8" - 14
LK4663-L	LK4664-R	4.44"	6-8000	1990 & Nwr	1" - 16	3/4" - 16

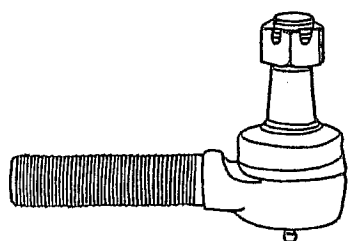

**CHEVROLET & GMC**

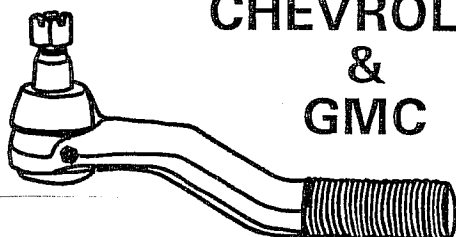

LH Threads Part No.	RH Threads Part No.	Length Center To End	Axle Size	Usage	Rod Thread Size	Stud Thread Size
LK4705-L	LK4706-R	6.50"	7000	1963-78	1-1/8" - 16	3/4" - 16
LK4709-L	LK4710-R	4.93"	7000	1973-91	1" - 16	3/4" - 16
LK2100-L	LK2102-R	10.75"	7000	1988-91	1-3/8" - 12	3/4" - 16
LK4701-L	LK4702-R	5.00"	8100	1993-95	1" - 16	3/4" - 16
LK4729-L	LK4730-R	5.44"	8100	1996 & Nwr	1-1/8" - 12	3/4" - 16
LK4717-L	LK4718-R	5.00"	9000	1975-91	1-1/8" - 12	3/4" - 16
LK4721-L	LK4722-R	5.00"	9000	1973-91	1-1/8" - 12	3/4" - 16
LK5813-L	LK5809-R	5.44"	9000	1987-88	1-1/2" - 12	7/8" - 14
LK4713-L	LK4714-R	5.44"	9-10000	1993 & Nwr	1-1/8" - 12	3/4" - 16

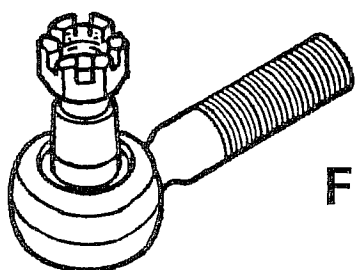

**FORD**

LH Threads Part No.	RH Threads Part No.	Length Center To End	Axle Size	Usage	Rod Thread Size	Stud Thread Size
LK4733-L	LK4734-R	4.43"	5-7000	1967-89	1" - 16	3/4" - 16
LK4709-L	LK4710-R	4.93"	6-7000	1990-92	1" - 16	3/4" - 16
LK4737-L	LK4738-R	6.07"	6-9000	1975 & Nwr	1" - 16	3/4" - 16
LK4725-L	LK4726-R	7.18"	7-9000	1995 & Nwr	1" - 16	3/4" - 16

**FREIGHTLINER**

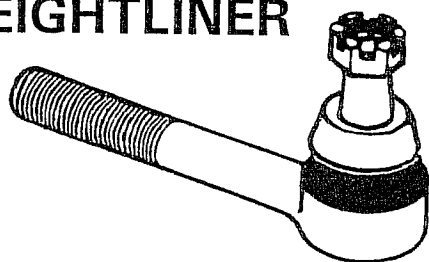

LH Threads Part No.	RH Threads Part No.	Length Center To End	Axle Size	Usage	Rod Thread Size	Stud Thread Size
LK6300-L	LK6309-R	No Info	8000	1995 & Nwr	No Info	No Info
LK6307-L	LK6308-R	No Info	10000	1995 & Nwr	No Info	No Info
LK6362-L	LK6364-R	No Info	12000	1995 & Nwr	No Info	No Info

**BLUE BIRD**

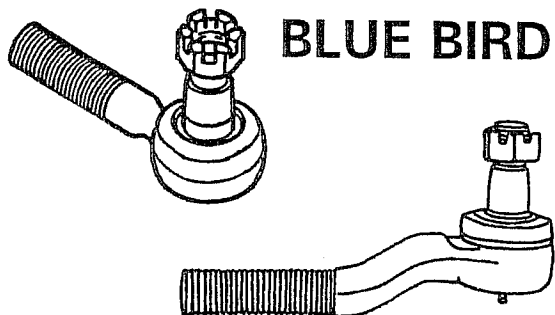

LH Threads Part No.	RH Threads Part No.	Length Center To End	Axle Size	Usage	Rod Thread Size	Stud Thread Size
LK6952-L	LK6953-R	5.44"	10800	1988-90	1-1/2" - 12	7/8" - 14
LK6954-L	LK6955-R	5.44"	12000	1991 & Nwr	1-1/8" - 12	7/8" - 14
LK6956-L	LK6957-R	9.18"	12000	1991 & Nwr	1-1/8" - 12	7/8" - 14
LK6958-L	LK6959-R	9.20"	14600	1992 & Nwr	1-1/8" - 12	7/8" - 14

**THOMAS**

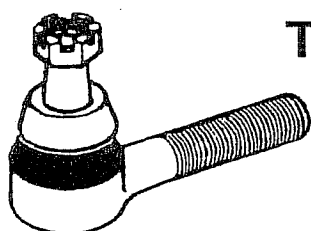

LH Threads Part No.	RH Threads Part No.	Length Center To End	Axle Size	Usage	Rod Thread Size	Stud Thread Size
LK9208-L	LK9209-R	5.44"	No Info	No Info	1-1/2" - 12	7/8" - 14
LK9212-L	LK9213-R	7.37"	No Info	No Info	1-1/2" - 12	7/8" - 14