

EASY TO INSTALL!

ENGINE PARTS

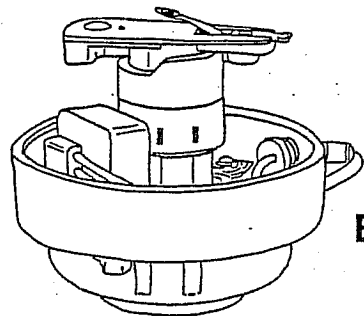

ELECTRONIC IGNITION CONVERSION KITS

NEVER CHANGE POINTS AGAIN!

- Unaffected by Moisture
- Eliminates Minor Tune-Ups
- No "Black Boxes" - No Points to Adjust
- No Complicated Wiring - Only (2) Wires To Connect

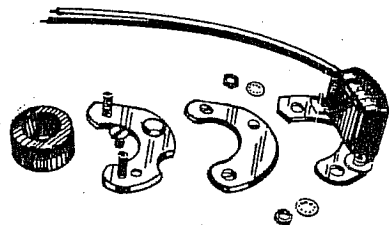

| YEAR | INTERNATIONAL HARVESTER | KIT # |
|---------|--|--------|
| | PRESTOLITE STANDARD DISTRIBUTOR | |
| 1964-up | V-345, V-392 Engines (w/Vac Advance) | LK6681 |
| 1974-up | MV-404, MV446 Engines (w/Vac Advance) | LK6682 |
| | IHC or HOLLY STANDARD DISTRIBUTOR | |
| 1971-78 | V-345, V-392 Engines | LK6683 |

ENGINE DIPSTICKS

- LK0275 GM
- LK0284 IH
- LK0283 Ford
- LK0287 Freightliner
- LK0286 Blue Bird

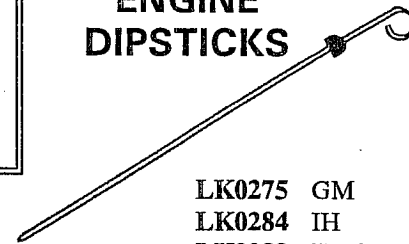

ENGINE DIPSTICK TUBES

- JK1098 GM
- JK1099 IH
- JK1100 Ford
- JK1101 Freightliner
- JK1102 Blue Bird

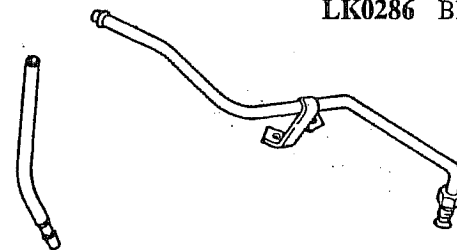

ENGINE BLOCK HEATERS

- LK0662 GM
- LK0687 IH
- LK0686 Ford
- LK0693 Freightliner
- LK0690 Blue Bird

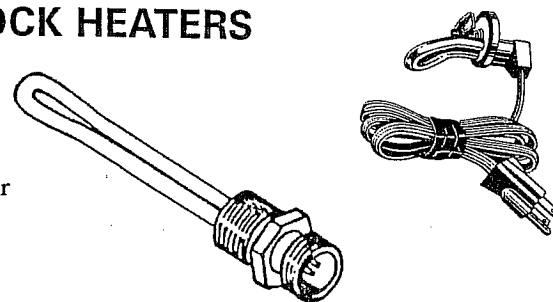

ELECTRONIC MODULES

- LK0723 GM
- JK0749 IH
- JK0748 Ford
- JK0751 Thomas
- JK0750 Blue Bird
- JK0752 Freightliner

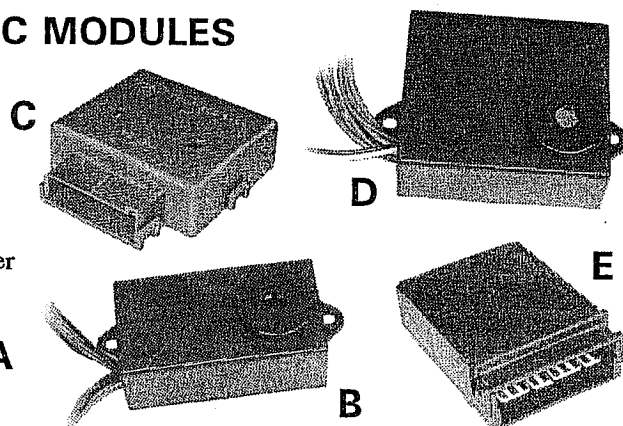

HARMONIC BALANCERS

- LK0585 GM
- LK0679 IH
- LK0678 Ford
- LK0685 Freightliner
- LK0684 Blue Bird

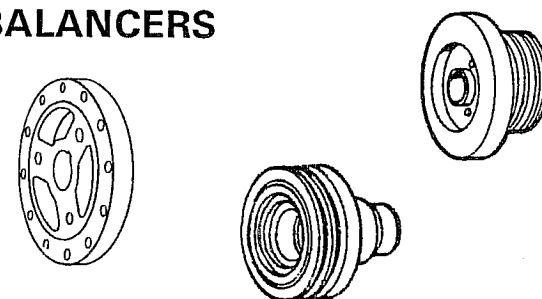

MOTOR MOUNTS

- LK0664 GM
- LK0668 IH
- LK0666 Ford
- LK0669 Freightliner
- LK0663 Blue Bird
- LK1332 Thomas

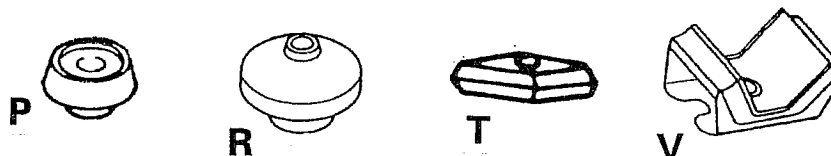
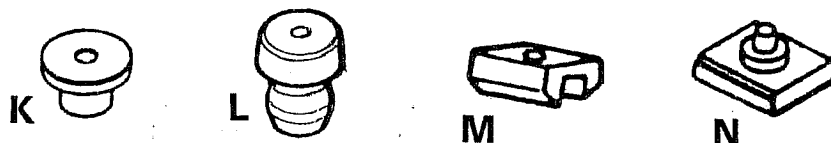
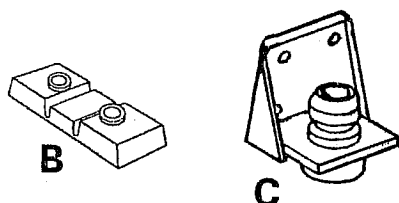

ENGINE OIL FILLER CAPS

- JK0340 GM
- JK0341 Ford
- JK0342 IH
- JK0343 Freightliner
- JK0344 Thomas
- JK0345 Blue Bird

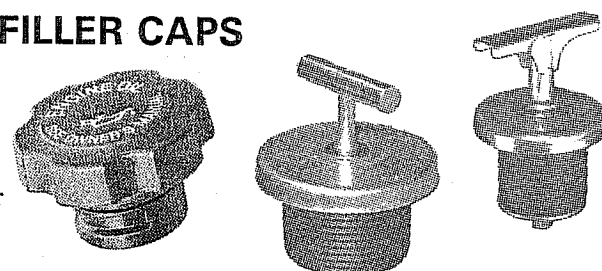

SMOG PUMPS

- LK0382 GM Pump
- LK0394 IH Pump
- LK0397 Ford Pump
- LK0401 Gasket
- LK0399 Pulley

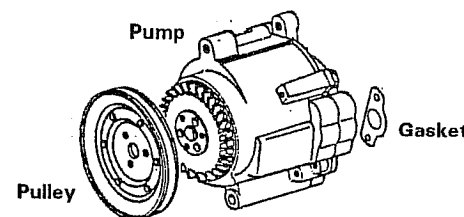

PEDAL PADS & ACCELERATORS

- LK7733 GM
- LK7736 IH
- LK7738 Ford
- LK7611 Freightliner
- LK7739 Blue Bird

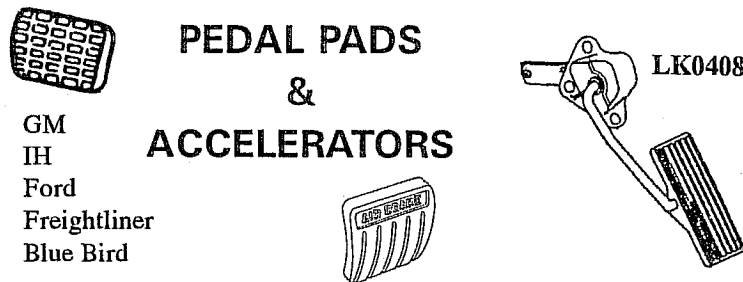

ACCELERATOR CABLES

- LK0351 GM
- LK0350 IH
- LK0371 Ford
- LK0689 Freightliner
- LK0348 Blue Bird

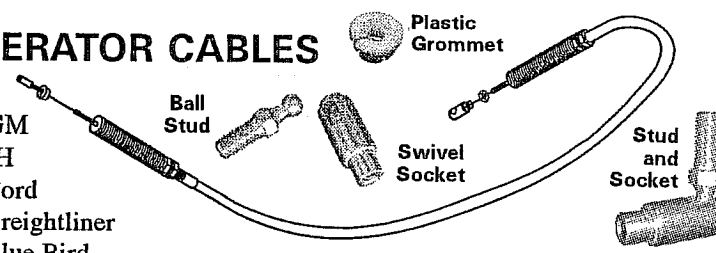

THROTTLE CONTROL PARTS