

LOW AIR WARNING SWITCH

LK1822

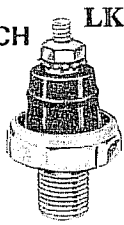

- Mounting Stem 1/8-27 Threads
- Fits All Makes

MISC. SWITCHES

LK1821

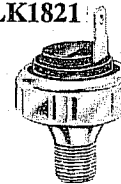

LOW VACUUM WARNING SWITCH

- Mounting Stem 1/8-27 Threads
- Fits All Makes

NEUTRAL SAFETY

AUTOMATIC TRANSMISSION NEUTRAL SAFETY SWITCH

LK4599

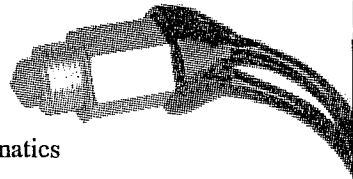

- For Allison Automatics
- (2) Wire Hookup
- Mounts on LH Side of Transmission
- Fits IHC, Chevy, GMC, & Ford

BACK-UP LAMP

AUTOMATIC TRANSMISSION BACK-UP LIGHT SWITCH

Pressure Activated

LK4594

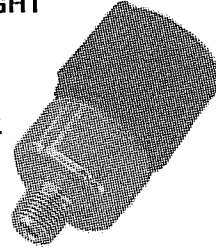

- For Allison Automatics
- (2) Bullet Terminals
- Fits IHC, Chevy, GMC, & Ford

BRAKE LAMP

BRAKE LAMP SWITCH

LK1215

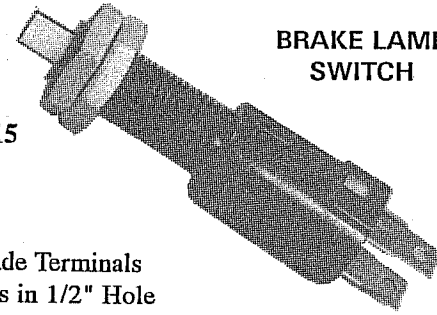

- (2) Blade Terminals
- Mounts in 1/2" Hole
- Fits IHC, Ford, Chev, GMC

AUTOMATIC TRANSMISSION NEUTRAL SAFETY SWITCH

Shifter Mounted

LK0208

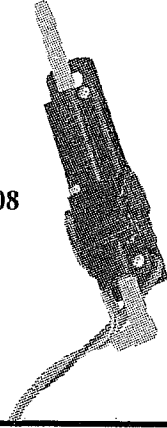

- For Allison Automatics
- (4) Wire Hookup
- Mounts in Shifter on Dashboard
- Fits GM, Blue Bird TC-2000

AUTOMATIC TRANSMISSION BACK-UP LIGHT SWITCH

1993 & Newer GM

LK1528

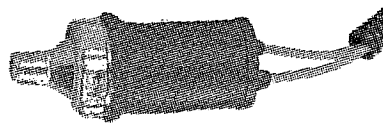

- For Allison Automatics
- (2) Conductor Harness with Plug
- Fits GM 1993 & newer

Pressure Activated

BRAKE LAMP SWITCH

LK5463

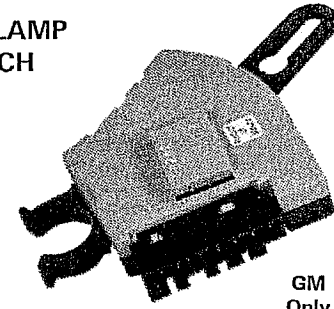

GM Only

- Connects to Harness Plug
- Fits GMC / CHEV 1993 & newer

PARK BRAKE

PARK BRAKE WARNING LAMP SWITCH

LK9274

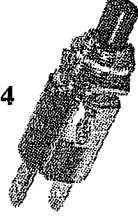

- (2) Terminals
- Mounts on Park Brake Control
- For IH only

BACK-UP ALARM and BACK-UP LAMP SWITCH

Magnetically Activated

LK1479

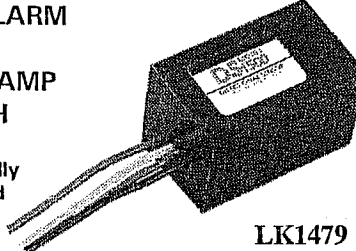

- (4) Wires
- Fits All Makes
- Includes Magnets for Drive Shaft

BRAKE LAMP SWITCH

Blue Bird Only

LK5997

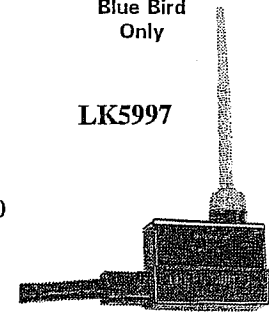

- (2) Conductor Plug
- Fits Blue Bird TC-2000 approx 1996 & newer

PARK BRAKE WARNING LAMP SWITCH

LK4595



- (2) Terminals
- Mounts on Park Brake Control
- For GM 1991 & older

AUTOMATIC TRANSMISSION BACK-UP LIGHT SWITCH

LK0208

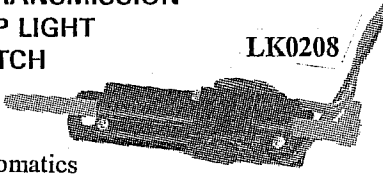

- For Allison Automatics
- (4) Wires
- Fits Chev, GMC, & Blue Bird TC-2000

BRAKE LAMP SWITCH

LK5973

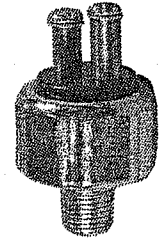

- (2) Screw Terminals
- Pressure Type
- Fits Blue Bird TC-2000 approx 1988-95

PARK BRAKE WARNING LAMP SWITCH

GM Only

LK9882



- (1) Terminal
- Mounts on Park Brake Lever
- For GM 1993 & newer

MANUAL TRANSMISSION BACK-UP LIGHT SWITCH

LK0654



- (2) Terminals
- For Manual Transmissions

BRAKE LAMP SWITCH

LK5762

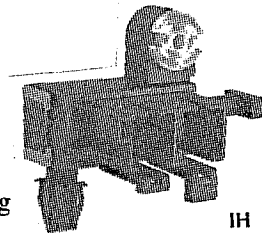

- Connects to Harness Plug
- Fits IH 1998 & newer

IH Only

PARK BRAKE WARNING LAMP SWITCH

Ford Only

LK2527



- (1) Terminal
- Mounts under Dashboard and on Frame near Rear Axle
- For Lucas Hydraulic Brakes only
- Fits Ford 1984 & newer

IGNITION SWITCHES

- LK0610 IHC
- LK0608 Chev/GMC
- LK0609 Ford
- LK0612 Blue Bird
- LK0611 Freightliner

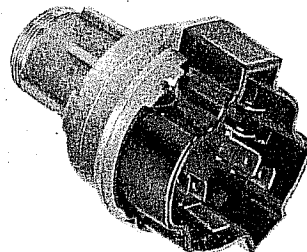

- (4) Positions: ACC-OFF-IGN-START

GM Switch Shown

CYLINDERS & KEYS

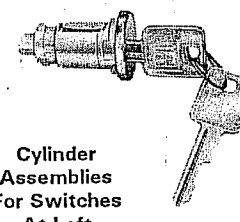

Cylinder Assemblies For Switches At Left

- LK0604 IHC
- LK0555 Chev/GMC
- LK0556 Ford
- LK0606 Blue Bird
- LK0605 Freightliner