

# HEADLAMP SWITCHES

BLUE BIRD  
1999-up

JK0970

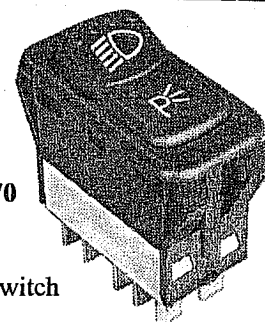

• Rocker Type Switch

BLUE BIRD  
HEADLAMP SWITCHES

TC-2000  
1994-98

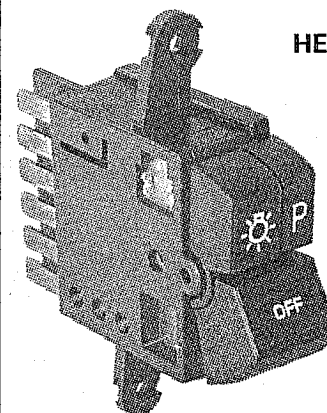

LK1788

• Rocker Type Switch  
• (6) Blade Terminals  
• For Blue Bird Only

## HEADLAMP SWITCH

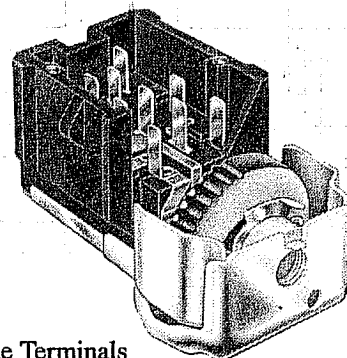

LK1823

- (9) Blade Terminals
- (3) Positions: OFF-ON-ON
- Fits Ford Chassis & Others
- Includes Internal Circuit Breaker
- Includes Dash Lights Dimmer Control

## HEADLAMP SWITCH

LK1825

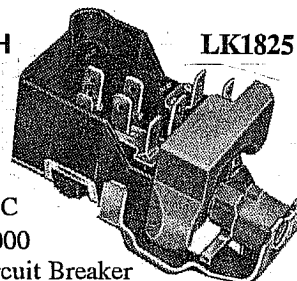

- (8) Blade Terminals
- (3) Positions: OFF-ON-ON
- Fits Chev, GMC, IHC & Blue Bird TC-2000
- Includes Internal Circuit Breaker
- Includes Dash Lights Dimmer Control

## HEADLAMP SWITCH

Knob & Shaft  
Only  
LK9984

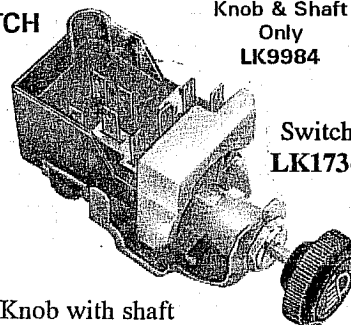

Plastic Connector  
Only  
JK1068

Switch  
LK1736

- Same as above, except:
- Includes Black Knob with shaft

## HEADLAMP SWITCH

LK1848

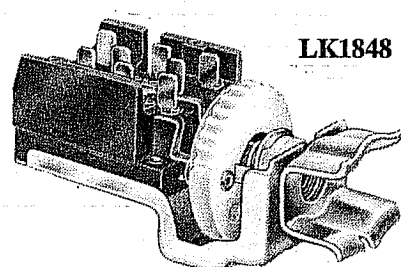

- Similar to above, except:
- (8) Blade Terminals

## IH-IC HEADLAMP SWITCH

LK9181

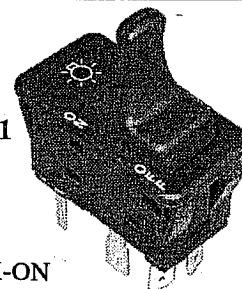

- Toggle Style
- For IH-IC, Amtran
- (7) Blade Terminals
- (3) Positions: OFF-PARK-ON

## HEADLAMP SWITCH

LK1592

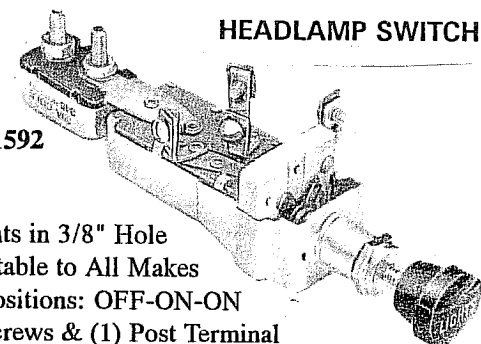

- Mounts in 3/8" Hole
- Adaptable to All Makes
- (3) Positions: OFF-ON-ON
- (4) Screws & (1) Post Terminal
- Includes 30-Amp Circuit Breaker
- Includes Dash Lights Dimmer Control

# FLOOR SWITCHES

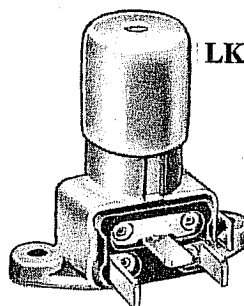

LK3162

## DIMMER SWITCHES

LK1820

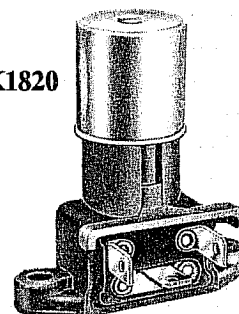

- (3) Blade Terminals
- Floorboard Mount
- Holes on 1-5/8" Centers
- Fits #LK3411 Connector shown at right

## DIMMER SWITCH CONNECTOR

LK3411



- (3) Wires
- Used With Dimmer Switches #LK3162 & #LK1820

## DIMMER SWITCH

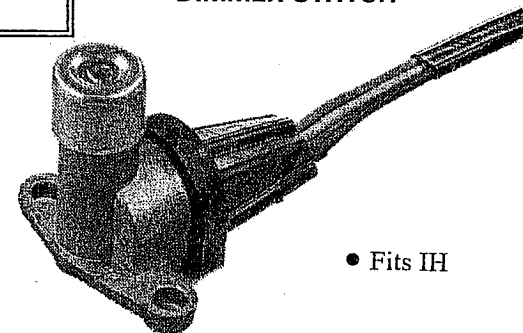

• Fits IH

LK2881 IH 1989 & Older - incl 32" Wire Harness  
LK2579 IH 1990 & Newer - incl 12" Wire Harness

## DIMMER SWITCH

TC-2000  
1994-98

LK7457

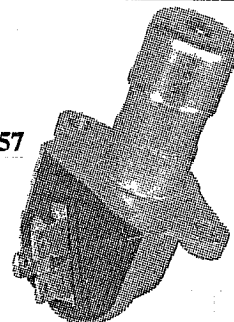

- (3) Blade Terminals
- Thru-Floor Mount
- For Blue Bird TC-2000

## DIMMER SWITCH CONNECTOR

LK3229

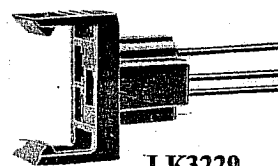

- (3) Wires
- Used With Dimmer Switch #LK3163

## MOMENTARY SWITCH FLOOR TYPE

LK3112

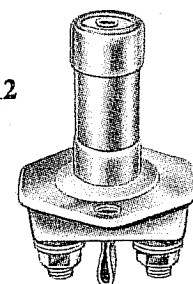

- (2) Post Terminals
- Long Neck Model
- Start 8-Lamp System
- (2) Positions: OFF-Momentary ON
- Fits Most Makes

## DIMMER SWITCH

LK3163

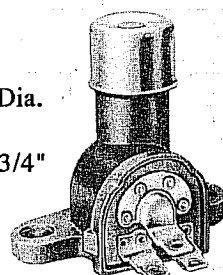

- Similar to above, except:
- Different terminal layout
- (1) Mounting Hole 17/64" Dia. & (1) Elongated Hole for Centers from 1-5/8" to 1-3/4"
- Uses #LK3229 Connector shown at right
- Fits Various Makes

TC-2000  
1988-93

LK3404

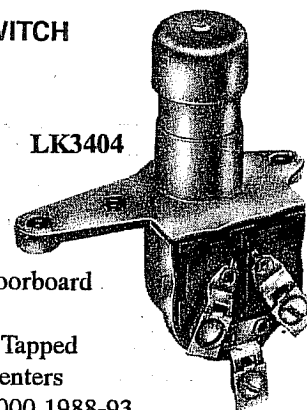

- (3) Screw Terminals
- Mounts Through Floorboard
- Stem 7/8" Diameter
- Attachment by 1/4" Tapped Holes on 1-3/4" Centers
- Fits Blue Bird TC-2000 1988-93

## MOMENTARY SWITCH FLOOR TYPE

LK3113

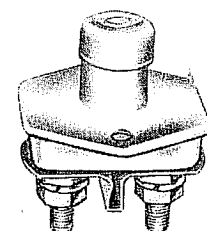

- Similar to above, except:
- Short Neck Model