

LK0523

Yellow is  
STD. Color

# HOOD & BODY PARTS

## WINTER FRONTS

Winter Fronts block the rush of cold air to your engine so that warm-ups are quicker.

You save time, fuel, and promote longer engine life. Heaters get hotter.....faster!

Winter Fronts can be worn "OPEN", or "CLOSED". They are secured in position with long lasting snap fasteners.

Make & Model	Part No.
Chevrolet 1969-83	LK6852
Chevrolet Tilt 1984-91	LK6856
Chevrolet 1993 & Newer	LK2036
Ford 1968-78	LK6861
Ford 1979-86 w/Plastic Grille	LK6854
Ford 1987-94	LK6859
Ford 1995 & Newer	LK2379
Freightliner 1996 & Newer	LK8795
GMC 1969-83	LK6601
GMC Tilt 1984-91	LK6855
GMC 1993 & Newer	LK2036
IHC Loadstar 1963-77	LK6860
IHC Loadstar Tilt 1972-77	LK6862
IHC "S" Model Gas 1978-89	LK6857
IHC "S" Model Diesel 1978-89	LK6858
IHC 3000 Series 1989 & Newer	LK6853

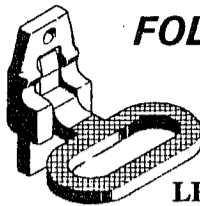

## FOLDING STEP

Heavy Duty Cast  
Fits All Makes

LK1307

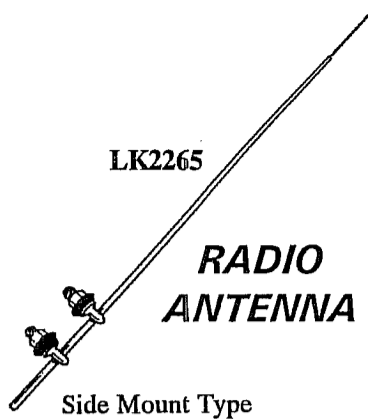

LK2265

## RADIO ANTENNA

Side Mount Type

## COWL HANDLES

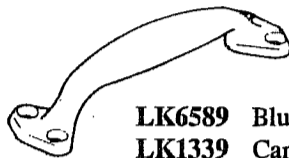

- LK6589 Blue Bird
- LK1339 Carpenter
- LK6591 Superior
- LK6595 Thomas
- LK6593 Ward
- LK6590 Wayne

## BODY MOUNTING CLIPS

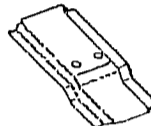

- LK6594 Blue Bird
- LK2272 Carpenter
- LK6596 Thomas
- LK6592 Wayne

## GM HOOD HINGES

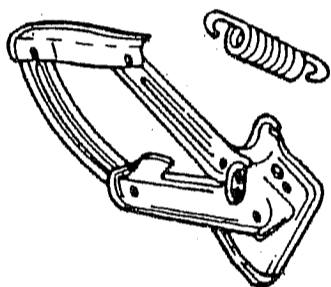

- LK9497 Spring Only
- LK9487 LH Hinge Only
- LK9493 RH Hinge Only

## HOOD GUIDES & BUMPERS

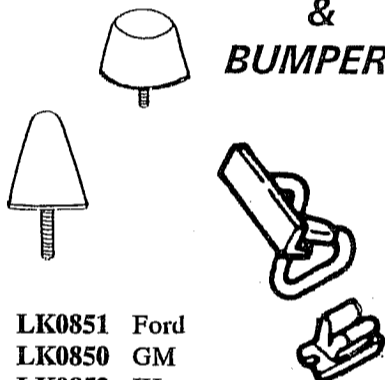

- LK0851 Ford
- LK0850 GM
- LK0852 IH
- LK0853 Freightliner

## MUD FLAPS



- LK0673 Front Flap
- LK0674 Rear Flap

## RIVETS

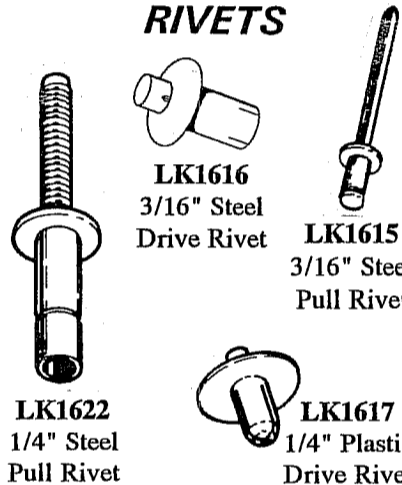

- LK1616 3/16" Steel Drive Rivet
- LK1615 3/16" Steel Pull Rivet
- LK1622 1/4" Steel Pull Rivet
- LK1617 1/4" Plastic Drive Rivet

## HOOD LATCH PARTS

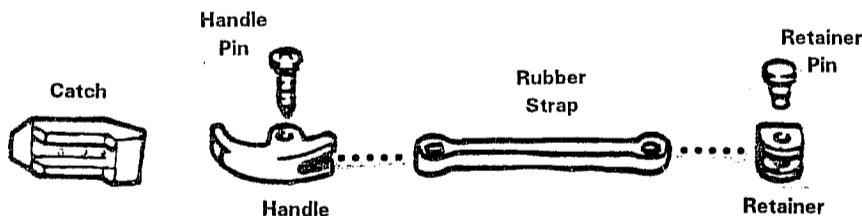

### CATCH ONLY

- LK3999 Ford LH
- LK4392 Ford RH
- LK3835 GM RH/LH
- LK2600 IH RH/LH
- LK2378 Freightliner

### HOOD LATCH KIT

(Includes Handle, Strap, Retainer, & Pins)

- LK4397 Ford
- LK4385 GM
- LK4399 IH
- LK2380 Freightliner

## BODY SEALER



COLOR	TUBE SIZE	PART NO.
Yellow Vinyl	11 oz.	LK6795
Grey Vinyl	11 oz.	LK6799
Black Silastic	11 oz.	LK6796
Clear Silastic	10 oz.	LK6798

## HOOD GLOVES - FOR IH & GM

Hood Gloves slip easily over the worn corners of the hood, then glue securely in place.

Hood damage is covered up.

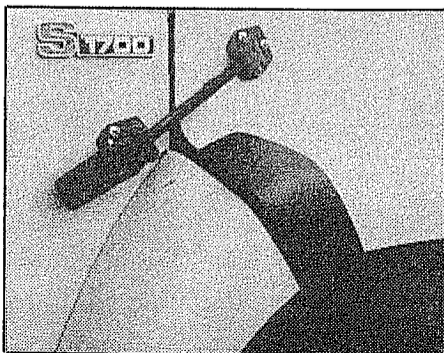

- LK6865 GM 1993 & Newer
- LK6863 IH 1990 & Newer
- LK6865 IH 1979-89

## BATTERY COMPARTMENT PARTS

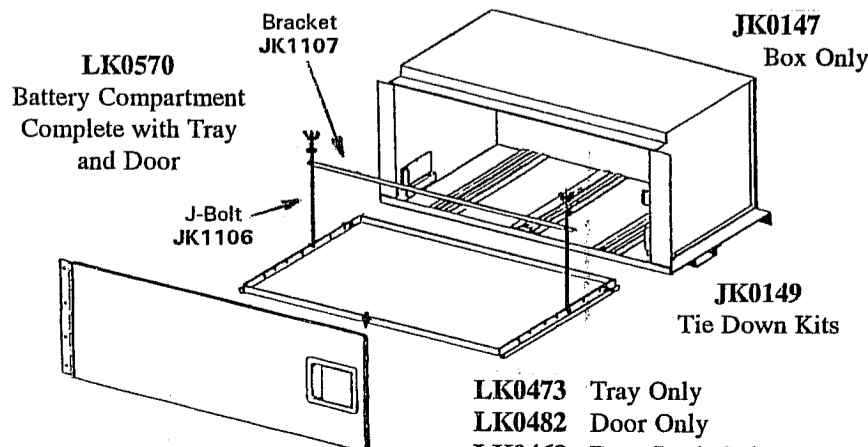

- LK0473 Tray Only
- LK0482 Door Only
- LK0468 Door Lock Only
- LK1300 Key Only

• FOR ALL MAKES