

CARRIER
RIFLED AIR
ACC
AMFAB

COMPRESSORS

A/C INDUSTRIES
SCOTT AIR
THERMO-KING
TRANS/AIR

HORIZONTAL PORTS

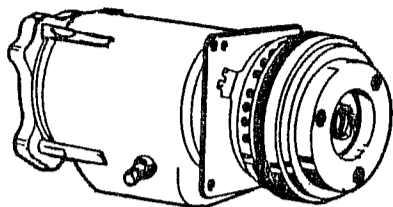

DELCO
Frigidaire
A-6
LK0627

HORIZONTAL PORTS

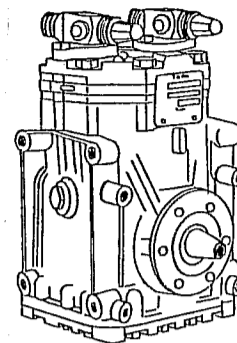

YORK
210

LK0629

ORDER CLUTCH SEPARATELY

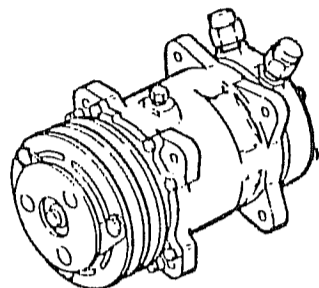

2-GROOVES

SANDEN

LK0602

LEG MOUNT

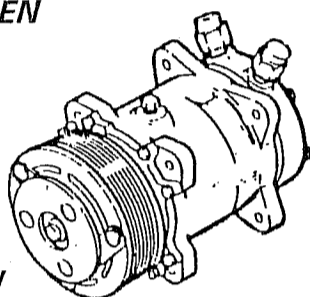

POLY-V

VERTICAL PORTS

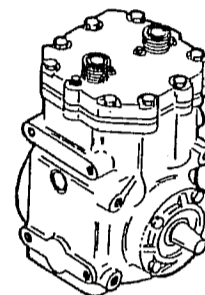

TECUMSEH
HGB-1000

LK8690

ORDER CLUTCH SEPARATELY

MITSUBISHI
MSN-230

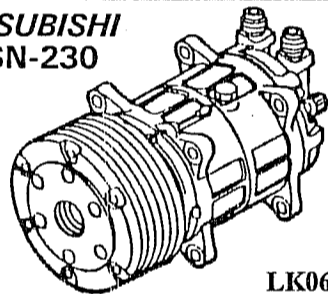

LK0628

RIFLED AIR

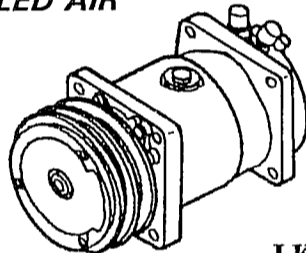

LK0631

DIESEL KIKI
DK-26

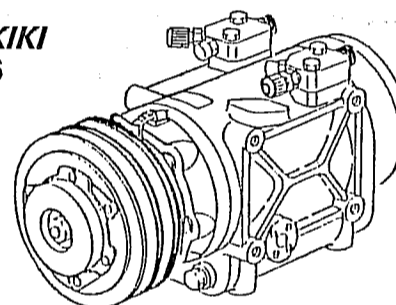

LK0622

HORIZONTAL PORTS

ENGINE MOUNT

CAN'T FIND THE COMPRESSOR YOU NEED?

Please Give Us The Following Information:

1. Name of Air Conditioning Manufacturer
2. Brand & Model No. of Compressor
3. Number of Pulley Grooves (1, 2, 6, 7, or 10)
4. Position of Ports (Vertical or Horizontal)
5. Type of Ports (Flare, Tube O-Ring, Rotolock)

WE CAN HELP YOU!

DIESEL KIKI
YA-15

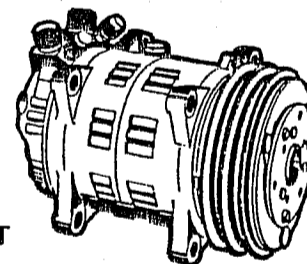

LEG MOUNT

LK0619

SANKYO

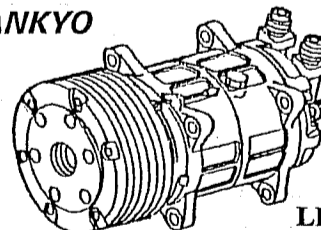

LK0607

SELTEC

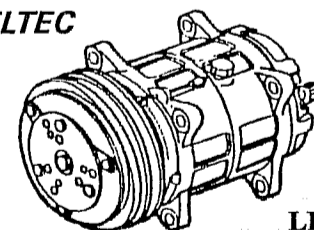

LK0613

COMPRESSOR APPLICATIONS

- JK0579 A/C - Carrier
- JK0580 ACC
- JK0581 ACT
- JK0582 Omega
- JK0583 Rifled Air
- JK0584 Scott Air
- JK0585 Thermo King
- JK0586 Trans-Air

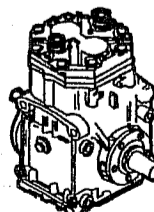

TAMA

LK0618

FORD
FS-6

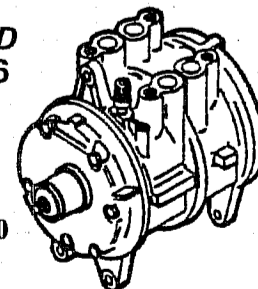

LK0630

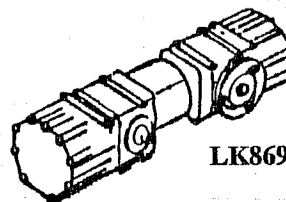

LK8694

TECUMSEH
DOUBLE COMPRESSORS
SCOTT UNDER-FLOOR POWER-PACK